

Heat-Generated Cooling Opportunities

Dr. Terry J. Hendricks
Valerie H. Johnson
Matthew A. Keyser

Center for Transportation Technologies and Systems
National Renewable Energy Laboratory
Golden, Colorado



1 Heat-Generated and Alternative Cooling Opportunities

Utilizing heat-generated cooling in vehicles offers the opportunity to reduce the amount of fuel used today for air conditioning. The U.S. uses approximately 11-14 billion gallons of gasoline each year for air conditioning in vehicles. By using waste heat as the primary energy source for heat-generated cooling, we have the potential to reduce the national fuel use by 11-14 billion gallons.

2 Magnitude of Available Waste Heat in a Typical US Car

Before researching heat-generated cooling opportunities, one must first determine the magnitude of the waste heat energy available from the engine in a vehicle to see if it is significant. The average fuel economy of a car in the US is near 21 mpg, and a representative vehicle could be the Ford Taurus with a 3.0-L engine and a maximum output power of 115 kW. Figure 1 shows that the waste heat available for a representative 115-kW engine varies from 20 to 400 kW across the engine map, with an average value over the FTP cycle of 23 kW. The temperatures of the waste heat range from 200°C surface temperatures to 600°C gas temperatures.

Generally, the waste heat available is twice as much as the mechanical output of the engine. An engine operating at a 30% thermal efficiency is releasing the remaining 70% of the fuel energy as waste heat through the coolant, exhaust gases, and engine compartment warm-up. During a typical drive cycle, the engine efficiency is lower than its maximum efficiency, and as this operating efficiency decreases (e.g. 30% to 15%), the magnitude of the waste heat increases, thus representing a larger energy potential to use for cooling via heat-generated cooling.

Clearly, the magnitude of energy currently wasted is significant, and a large opportunity exists to utilize this waste heat for productive purposes.

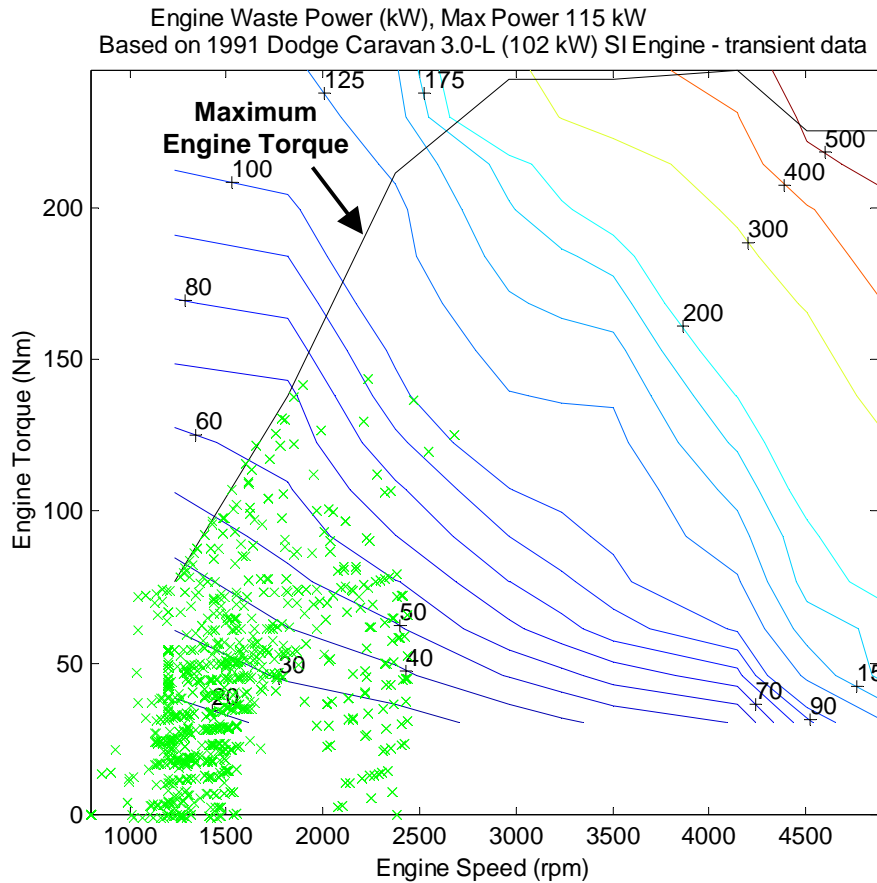

Figure 1: Engine waste heat for a 3.0-L 115 kW engine (x's are engine operating points for a 21-mpg vehicle over an FTP drive cycle)

3 Heat-Generated and Alternative Cooling Systems

3.1 Metal Hydride Systems

System Operation

Hydride heat pumps utilize the fact that when hydrogen is adsorbed by the metal, heat is released because it is an exothermic reaction. Desorbing or releasing the hydrogen is endothermic, which needs heat as an input and acts the same as the evaporator in a vapor-compression system. In the equation below, M represents the metal, and MH_x the metal hydride:

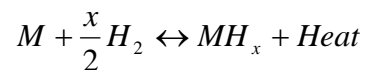

Figure 2 shows the basic operation of a hydride heat pump, for one particular configuration. This system uses two metal hydride beds (a low temperature and high temperature metal), three heat exchanger sections (high, ambient, and low temperatures), and cycles the beds through these heat exchangers through time to achieve cooling.

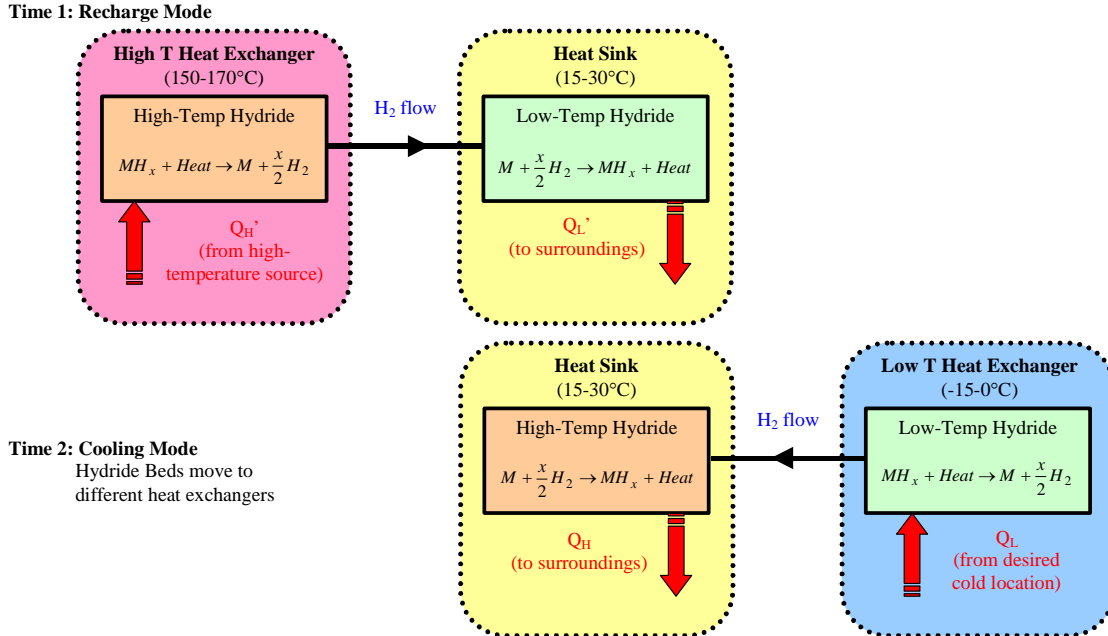

Figure 2: Basic Operation of Metal Hydride Heat Pump

Materials

Example high-low temperature hydride materials are $LaNi_{4.75}Al_{0.25}$ (160°C) and $MmNi_{4.15}Fe_{0.85}$ (-10°C), or $ZrCrFe_{1.1}$ (120°C) and $LaNi_5$ (20°C). The cost of the hydride is ~\$300/kg and the amount of hydride in a bed ranges from 0.122-0.6 kg (\$37-180). Hydride metals have been cycled 100,000 times reliably. Development on hydrides by companies has been mainly related to nickel-metal-hydride battery research and solid-state storage applications (e.g. fuel cell energy sources).

Advantages and Disadvantages

Metal hydride systems have fewer total parts and fewer moving parts than a conventional vapor compression air-conditioning system, as the system doesn't use a compressor or evaporator. Therefore, a hydride system would also have lower maintenance costs. A far-reaching advantage of a metal hydride system is that it does not require chloroflourocarbons (CFC) for cooling. CFC's, such as freon, have been linked to the destruction of stratospheric ozone that protects the earth by limiting ultraviolet radiation.

A significant obstacle to overcome before hydride cooling systems will be viable in a vehicle is a low Coefficient of Performance (COP). Currently their typical COP is 0.4, with maximum values up to 2.5. These numbers are lower than commercial vapor compression refrigerators, whose average COP's are near 1.5. In order to increase the performance of the system, it is necessary to research improved heat exchanger

efficiency, smaller component sizes, and system integration with the vehicle waste heat. These are all significant and challenging areas.

Past Research Performed

Ergenics, based in New Jersey, created a metal hydride 5-kW AC system powered by waste heat from simulated exhaust gases in 1992-1993. Ergenics has been awarded several patents surrounding their metal hydride cooling system. The system mass was 22 kg and the COP was 0.33. They didn't have strong external interest, so as a company they've focused on development of metal hydrides for solid state hydrogen storage.

Thermacore, based in Pennsylvania, constructed two prototype metal hydride heat pumps in 1997-1998 based on two Russian inventions that could significantly improve the efficiency of a hydride system. They were awarded US Patent #6,000,463 in 1999 for a "Metal Hydride Heat Pump." *Note that the following numbers are Thermacore sensitive/proprietary numbers, for distribution only within DOE.* One of the prototype designs used self-propelled cycling, operated on a 55-minute period, cooled to -10°C , and saw peak cooling rates of 70 W for 3-4 minutes. The second design was manually controlled for a 5-minute cycle, dropping temperatures 6°C (from 22 to 16°C). Overall, the prototype heat pump was capable of producing an average of 3.4 W "cold" and a peak of 4.5 W using 180°C heat with an average COP of 0.1 and a peak COP of 1.5 to 2.5. Thermacore is not currently funding hydride development.

Advanced Materials Corporation, a small company based in Pennsylvania, developed a prototype hydride system in 1986 for a contract for the state of Pennsylvania. Their hydride heat pump used a pump to transfer the hydrogen and provide heating and cooling using a different configuration than that described above. They put the system in the trunk of a vehicle and cooled the cabin. The system had a mass of 40 kg and achieved 350 W of cooling at 16°C . They have shown interest in putting together a prototype hydride system with NREL to operate with waste heat.

Other work and modeling of hydride systems has been performed at the University of New Mexico, Albuquerque, the University of Illinois at Chicago, the University of Melbourne, Australia, and the National Academy of Sciences of Ukraine (1998-present).

3.2 Absorption Systems

System Operation

Absorption refrigeration cycles differ from vapor-compression cycles in the manner in which compression is achieved. In the absorption cycle, the low-pressure refrigerant (e.g. ammonia or lithium bromide) vapor is absorbed in water and the liquid solution is pumped to a high pressure by a liquid pump. Figure 3 shows a schematic of the essential elements in an absorption system. A lithium bromide absorption heat pump uses LiBr as the working solution. The lithium bromide-based absorption chiller has been around commercially since the late 1950's and uses bromide brine with concentrations of ~60%. The ammonia-water absorption system has been around since the early 1900's.

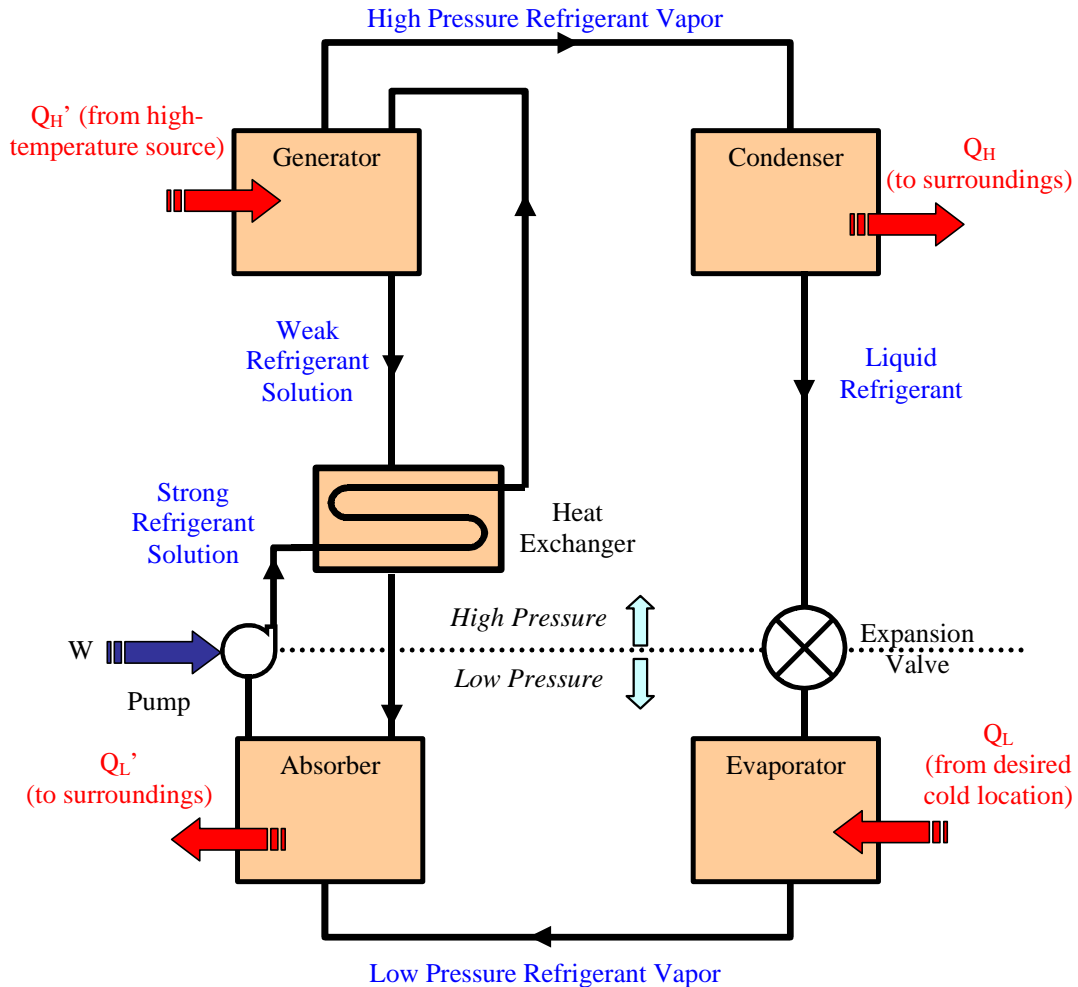

Figure 3: Schematic of Absorption Heat Pump Cycle

Advantages and Disadvantages

The distinctive feature of the absorption system is that very little work input is required because the pumping process involves a liquid. Another advantage is that they have been around for a long time, such that there is a manufacturing basis for larger systems (e.g. applications for manufacturing plants, buildings).

However, a relatively high-temperature source of heat (100° to 200°C) must be available for the absorption system. There is more equipment in an absorption system than in a vapor-compression system, and it can usually be economically justified only when a suitable source of heat is available that would otherwise be wasted. This is the case if vehicle waste heat is used. COP's are near 1. There may be some safety related issues in transporting ammonia or lithium bromide in vehicles, which could cause significant resistance to absorption systems in the automobile industry. Another disadvantage is that corrosion in the evaporator can occur. Lithium bromide, a highly corrosive brine, readily attacks ferrous metals such as steel. The corrosion process generates hydrogen gas that reduces the internal vacuum inside the evaporator, and the unit operates poorly. In

addition, the debris resulting from the corrosion fouls narrow openings in spray headers, heat exchangers, etc.

Past Research Performed

Gas Research Institute, based in Chicago Illinois is researching absorption heat pumps. Shuangliang Teling Lithium Bromide Refrigeration Machine Co., Ltd, as implied by its name, produces lithium bromide refrigeration systems. However, not much work has been performed on integrating such a system into a vehicle.

3.3 Zeolite Systems

Zeolite systems are similar to metal hydride systems, but uses zeolite and water in the place of a metal hydride and hydrogen. The natural mineral zeolite (e.g. porous aluminosilicate) has the property to attract (adsorb) water vapor and to incorporate it in its internal crystal lattice while releasing heat at the same time:

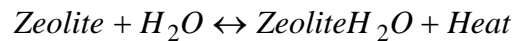

System Operation

A zeolite system requires cycling between adsorption and desorption. Figure 4 shows the adsorption phase. For a comparison to the absorption heat pump described in Figure 3, the left container (sorber) in Figure 4 takes on the role of the Absorber, and the right container is the Evaporator. Heat is released in the zeolite, and cooling is seen at the evaporator. If absorption proceeds in an evacuated (airless) environment the attraction of water by the zeolite is so forceful that the internal pressure drops dramatically. The remaining water in an attached vessel evaporates, cools down and freezes immediately due to the heat of evaporation. The resulting ice can be used for cooling and air conditioning while the simultaneously produced heat of adsorption within the zeolite tank can be utilized for heating.

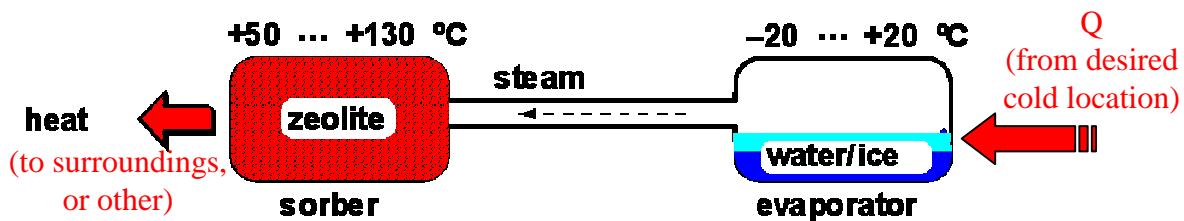

Figure 4: Adsorption phase of a Zeolite system

Figure 5 shows the desorption phase. Again, for a comparison to the absorption heat pump described in Figure 3, the left container (sorber) in Figure 5 takes on the role of the Generator, and the right container is the Condenser. When the zeolite is saturated with water, desorption is initiated by heating the zeolite at high temperatures. The adsorbed water molecules are forced to evaporate (desorption), and condensation takes place in the water tank (condenser). The sequence of adsorption/desorption processes is completely reversible.

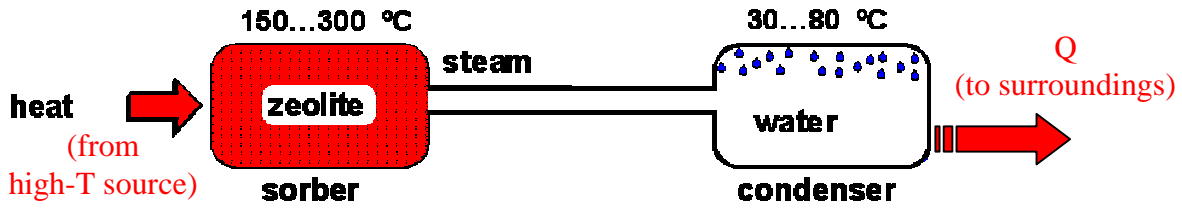

Figure 5: Desorption phase of a Zeolite system

Materials

Currently the chemical industry produces more than 1.4 million tons of synthetic zeolite annually and it can be expected that the worldwide demand and consequently the production will further increase. Zeolites are currently used as catalysts for refining oil in the petroleum industry, as filler in paper production, and as ion exchange material in detergents. The price, e.g. for laundry detergent zeolite, is between \$0.45-3.60/kg, depending on the type and consistency of material delivered.

Advantages and Disadvantages

The adsorption of zeolites is very strong, thereby providing the family of materials with unique adsorption properties and permitting extremely high efficiencies for adsorption heat pump cycles with air-cooled condensers (COP's around 1.2 shown). Another advantage of zeolite systems is that they allow heating and cooling at the same time. This might be useful, for example, to heat the catalyst for quick lightoff, while cooling the cabin compartment for interior thermal comfort.

One disadvantage of zeolite systems is that to provide continuous cooling, systems need to cycle between multiple sorption modules. As with metal hydride systems, research needs to be performed to develop smaller components and system integration with the waste heat in a vehicle.

Past Research Performed

Zeo-Tech, a German company, has developed a zeolite heat pump, officially registered as one of the EXPO2000 projects. The device, shown in Figure 6, is fired by a gas-burner. Energy savings are 25% over state of the art technologies (e.g. condensing boiler) for heating. In the future, Zeo-Tech plans to build and optimize a zeolite heat pump with integrated ice-storage for a typical one-family house with a rated heating power of approximately 10 kW.

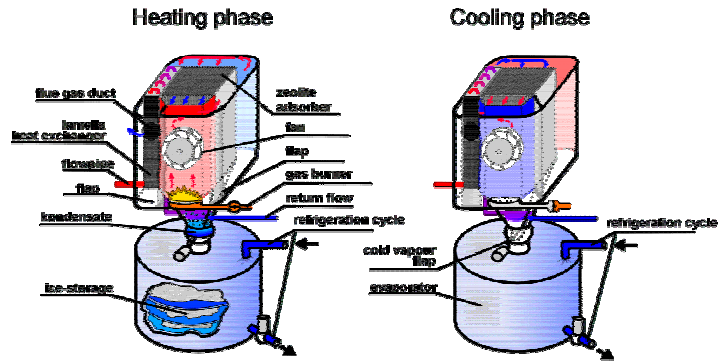

Figure 6: Zeo-Tech's prototype Zeolite Heat Pump

The Gas Research Institute, Chicago, IL, and Zeopower, Co., MA, created a closed-cycle regenerative zeolite heat pump fired by natural gas in 1989. Combining the zeolite technology with the principle of energy regeneration resulted in a single-effect system with seasonal cooling coefficients of performance (COPs) of 1.2 and heating COPs above 1.8 and initial equipment cost comparable to electric heat pumps.

A demonstration unit with ZAE-Bayern, Germany, was performed in 2000.

Other research has been performed at KIER (Korea Institute of Energy Research), as shown in Figure 7. The capacity of a prototype zeolite adsorption heat pump was 1.4 W and the system COP was 0.3. The system cycled in two hours.

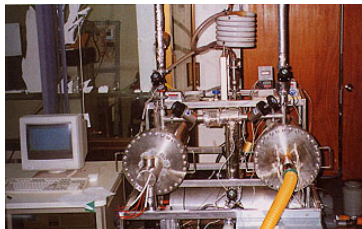

Figure 7: KIER's prototype Zeolite AHP

3.4 Thermoacoustics

System Operation

Thermoacoustic refrigerators use sound waves to pump heat. They are based on the fact that accompanying pressure and velocity changes with a sound wave are small temperature oscillations. Near a solid boundary, the combination of temperature oscillations with pressure and velocity oscillations produces a rich variety of thermoacoustic effects. With intense sound waves in suitable geometries, these effects can be harnessed to produce powerful thermoacoustic engines and refrigerators. Sound levels inside reach 180 dB, but outside the system is as quiet as a conventional AC system. An example working fluid is helium.

As a parcel of gas moves to one side, say to the left, it heats as the pressure rises and then comes momentarily to rest before reversing direction. Near the end of its motion, the hot

gas transfers heat into the stack, which is somewhat cooler. During the next half-cycle, the parcel of gas moves to the right and expands. When it reaches its rightmost extreme, it will be colder than the adjacent portion of the stack and will extract heat from it. The result is that the system pumps heat from right to left and can do so even when the left side of the stack is hotter than the right (“The Power of Sound,” American Scientist, 2000).

Figure 8 shows the basic operation of a thermoacoustic heat pump. A stack is utilized to keep the sound wave in location long enough for heat transfer to occur.

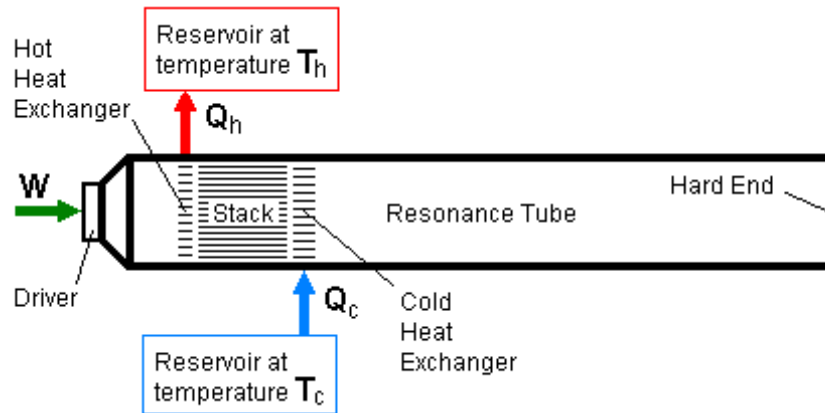

Figure 8: Basic Operation of a Thermoacoustic Heat Pump

Standing Wave vs. Traveling Wave

Initial work on thermoacoustics centered on developing a standing acoustic wave in a resonant cavity. In an example standing wave system, cooling of 400 W was seen with an input of 200 W acoustic power (COP = 2, which was 17% of ideal Carnot efficiency). Recently, the DOE group at Los Alamos National Laboratory (LANL) has made a breakthrough developing a thermoacoustic heat engine that uses a variation of the Stirling cycle (with a porous regenerator), and uses a traveling acoustic wave. Their first heat engine of this design (see Figure 9) produced power from a heat input at an efficiency of over 40% of Carnot, 150% greater than the best standard thermoacoustic heat engines (e.g. 42% vs. 17% efficient).

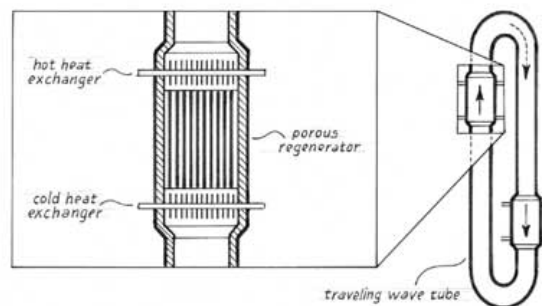

Figure 9: LANL Traveling Wave Thermoacoustic Heat Pump

Advantages and Disadvantages

Thermoacoustic systems appear attractive because of their elegance, reliability, and low cost, in spite of only modest efficiency. They are environmentally safe and have no sliding parts. This difference makes thermoacoustic devices much simpler and potentially much more reliable than conventional engines and refrigerators, because they can avoid wear associated with valves, piston rings, crankshafts, connecting rods and so forth. Thus thermoacoustic devices require no lubrication.

Disadvantages of thermoacoustic systems are low efficiency and low power density. Research is predicted to give efficiencies comparable to vapor-compression refrigerators. Another significant disadvantage of thermoacoustic systems is their typically large size. Also, thermoacoustic devices are very sensitive devices—if the standing or traveling wave gets out of phase for any reason (e.g. dirty heat exchangers, shock or vibration), the cooling can be disrupted. Today, thermoacoustic refrigerators are used in special applications and temperature changes of 25°C have been achieved. More research is needed in order to get commercially marketable devices, in particular research to focus on heat exchanger design, transducer design, sizing, robustness, and increasing overall efficiency and decreasing price.

Past Research Performed

A qualitatively accurate theory was developed in the 1970s and the first thermoacoustic refrigerator was built in 1985. Hence, this technique is relatively new. So far, most machines of this variety reside in laboratories. But prototype thermoacoustic refrigerators have operated on the Space Shuttle and aboard a Navy warship (cooling radar electronics).

Most of the work related to thermoacoustics has been performed at LANL (funded by the DOE's Office of Basic Energy Sciences), Penn State University, and the Naval postgraduate school (CA), with additional work at the University of Utah, and Chalmers University of Technology. The First International Workshop on Thermoacoustics was held in 2001 in the Netherlands with 80 attendees. The workshop showed that an understanding of combustion oscillations by thermoacoustics is on its way, and numerical simulations are in reasonable agreement with experiments. LANL's numerical simulation tool is named DeltaE (Design Environment for Low-amplitude Thermoacoustic Engines).

Additionally, large-scale thermoacoustic traveling wave machines are under development. These machines are used to drive large-scale pulse-tube coolers in the kW or MW range. As an example, the thermoacoustic Stirling engine designed at LANL weighs 200 kilograms and measures 3.5 meters long (see Figure 10). This device is under development for the commercial application of liquefying natural gas.

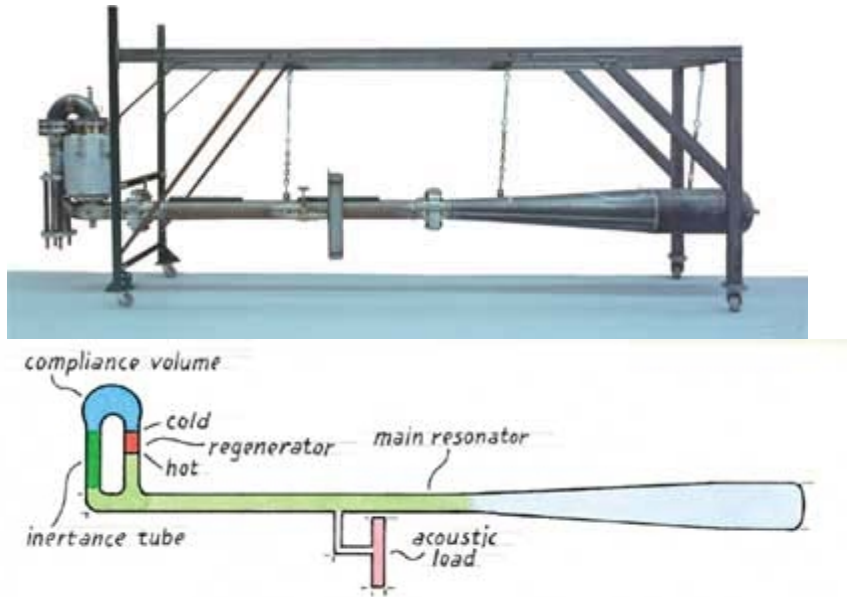

Figure 10: LANL's Thermoacoustic Sterling Engine

At Penn State, a prototype thermoacoustic chiller, Figure 11, has been designed, constructed and tested that has a greater power density than any other electrically driven thermoacoustic refrigerator to date. The chiller was developed in conjunction with Ben & Jerry's Hand Made Ice Cream in order to reduce the amount of emissions that contribute to global warming. The prototype machine, which is 10 inches (25.4 cm) in diameter and about 19 inches (48.3 cm) tall, has a cooling capacity of 119 W at a temperature of -24.6 °C. The overall coefficient-of-performance (defined as the ratio of the cooling capacity to the electrical power consumption) of the chiller is measured to be 0.81 or 19% of the Carnot COP at the capacity and temperature listed above.

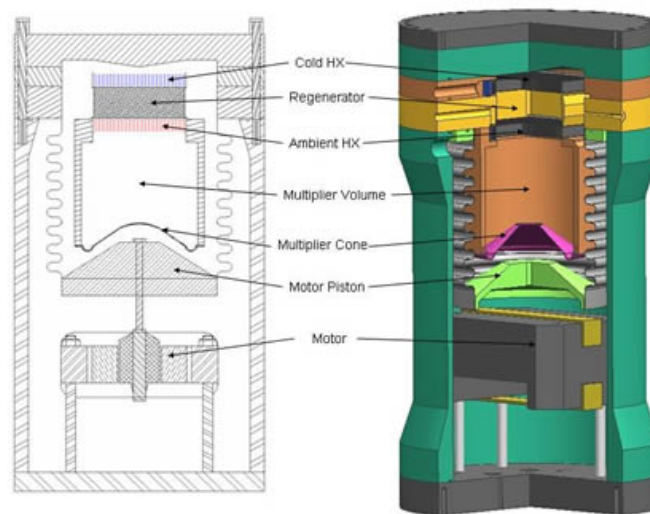

Figure 11: Penn State and Ben & Jerry's Thermoacoustic Ice Cream Chiller.

3.5 Magneto-Caloric Heat Pumps

System Operation

Magneto-caloric heat pumps are based on the fact that magnetic materials change their temperature with changes in magnetic field (named the magneto-caloric effect, or MCE). A magnetic heat pump uses the magnetic property of materials and magnetic fields to pump heat from a low to a high temperature. Magnetic-caloric materials heat or cool when they are magnetized or demagnetized (a form of phase change) as a result of changing the entropy of the material.

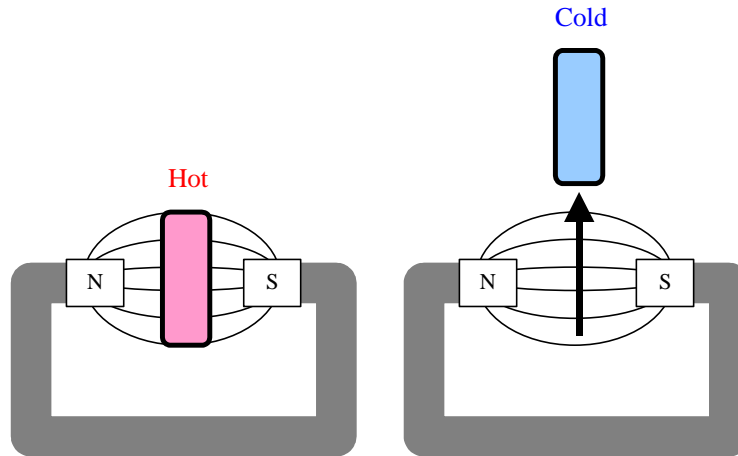

Figure 12: Magneto-Caloric Effect (MCE)

The utilization of the magnetocaloric effect has been known since 1924 as a method to achieve temperatures below 0.3K. In the past ten years there has been an increasing amount of research on the use of MCE as a method of continuous cooling for industrial and commercial applications (i.e. liquefaction of cryogenic gasses, freezers for food processing plants, supermarket chillers and large building air conditioning), because it appears that magnetic refrigeration can be cost effective and save considerable energy in certain instances over conventional gas compression technology.

Materials

Materials with magnetocaloric effects include samarium cobalt and gadolinium. Recently, gadolinium-silicon-germanium alloys showed a cooling effect two times that of pure gadolinium. Existing work in high-temperature superconducting materials will support magneto-caloric heat pumps.

Magneto-caloric heat pumps require a superconducting magnet to provide strong magnetic fields with essentially no resistive losses. Typical field strength is 8 Tesla (1T = 10^4 G, Earth 0.5 Gauss) to produce a magnetocaloric temperature change of 15K in rare-earth materials.

Advantages and Disadvantages

The major advantages of magnetic refrigeration technology, with application to automobile air conditioners, household refrigerators, and heat pumps, are:

environmentally friendly, high energy-conversion efficiency—potentially high due to the high reversibility of the magneto-caloric effect, and energy-savings as there is no compressor required. There is also a potentially dramatic reduction in the complexity, size and mass of the cooling unit.

However, magnetic freezing technology was previously considered impractical for air conditioners, refrigerators and other electric appliances because a single change in a magnetic field yields only minimal change in the temperature of a magnetic material. Magneto-caloric cooling currently produces only minimal cooling (e.g. 300 W), which would be insufficient for cooling an automobile (4 kW). Another disadvantage is the material costs and high capital costs due to the need for magnetic shielding, especially in vehicles. This could limit the technology to niche markets. The weight of magneto-caloric systems could also be a disadvantage in terms of fuel economy impacts of moving mass.

Past Research Performed

As a CARAT project in 1998-1999, Iowa State University performed research on "Development of Vehicle Magnetic Air Conditioning Technology." They collaborated with the Astronautics Corporation of America on the project. Their results indicated that personal cooling (<1 kW) was more viable than an overall air conditioner system (3-6 kW). They saw changes in temperature of 4K with a 2 Tesla magnetic field, and up to 13K with a 10 T field.

In October 2000, in cooperation with Toshiba Corp, Chubu Electric Power Co. developed the world's first magnetic freezing system. They reduced the temperature from 28°C to -1°C using gadolinium (Gd) as a magnetic material. The system demonstrated a COP of 4.3.

With funding from the EPA, the National Center for Environmental Research at George Washington University currently has a \$250K grant through 2003 for "Preparation of Superferromagnetic Lanthanide Nanoparticulate Magnetic Refrigerants." This research looks at magnetic nanocomposites instead of either paramagnetic or ferromagnetic materials for magnetic cooling at ambient temperatures.

3.6 Ejector Refrigeration

System Operation

Ejector refrigeration cycles differ from vapor-compression cycles in the manner in which compression is achieved. In the ejector cycle, the low-pressure refrigerant (e.g. water) is driven by fluid kinetic or thermal energy as opposed to pumps or compressors which are driven by mechanical energy. Figure 13 shows a schematic of the essential elements in an ejector system. The waste heat from the exhaust would be utilized to convert water to super heated steam. The steam would then be utilized by a steady-stream ejector or turbomachinery to compress a secondary water stream.

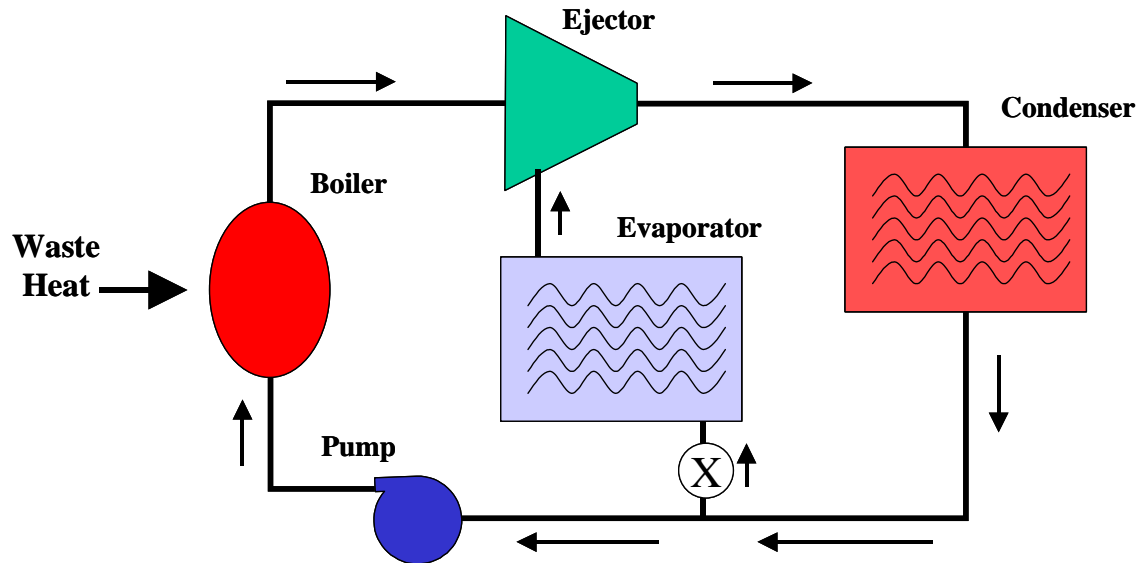

Figure13: Schematic of Ejector Refrigeration Cycle

Advantages and Disadvantages

The ejector refrigeration cycle has the distinct advantage of being environmentally friendly when water is used as the working fluid – other refrigerants can be used in the cycle. Like the absorption system, the ejector refrigeration cycle requires very little work input because the pumping process involves a liquid.

The ejector can either be a steady-flow ejector or can be replaced by a turbine-compressor. Steady-flow ejector’s have been in development over the past century and are unlikely to attain COP’s greater than 0.2. Turbine ejector’s have the potential for greater COP’s but such a system would be expensive and require large components if water were used as a refrigerant. (Garris, C., et al, “A New Thermally Driven Refrigeration System with Environmental Benefits”, 33rd Intersociety Engineering Conference on Energy Conversion, 1998) Furthermore, turbomachinery is somewhat unforgiving with regards to sealing and bearing requirements considering the rotational speed of the turbine, upwards of 75,000 rpm. Research is on-going and it is hoped that within the next several years the performance of turbomachinery will demonstrate improvements over steady-state flow ejectors.

Past Research Performed

The University of Nottingham has been at the forefront of the development of micro-combined heat and power (CHP) systems using renewable energy for a number of years. The main achievement has been the development of a micro-CHP system that is capable of producing electricity, heating and cooling from the same cycle and the demonstration of this cycle. The Rankine cycle has a 1.5kW electrical output and operates with an efficiency of 4% and the ejector cooling cycle has a 3kW cooling effect at a COP of 0.35. The system has been shown to provide a performance competitive with other methods of

electricity generation, heating and cooling in terms of emissions. The system (Figure 14) would be ideal for remote applications, as it is relatively compact.



Figure 14: University of Nottingham ejector cooling system capable of heating, cooling, and electrical power generation.

Mayekawa has developed an ejector type engine-driven cooling system utilizing low temperature waste heat exhausted by marine engines. Air-conditioning (cooling and heating) and dehumidification of ship's cabins is possible with this system shown in Figure 15. The unit is a prototype and is not commercially available.



Figure 15: Mayekawa ejector type engine-driven cooling system.